

MEDPOR[®]

Neuro surgery

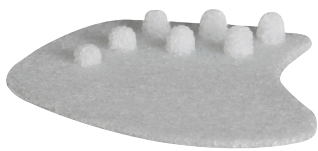

MEDPOR biomaterial

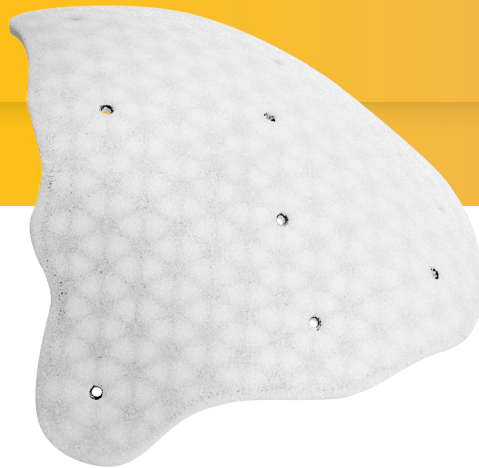
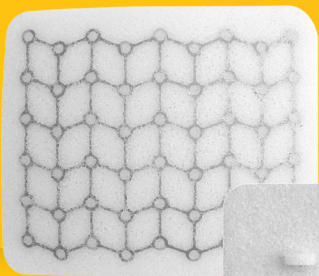
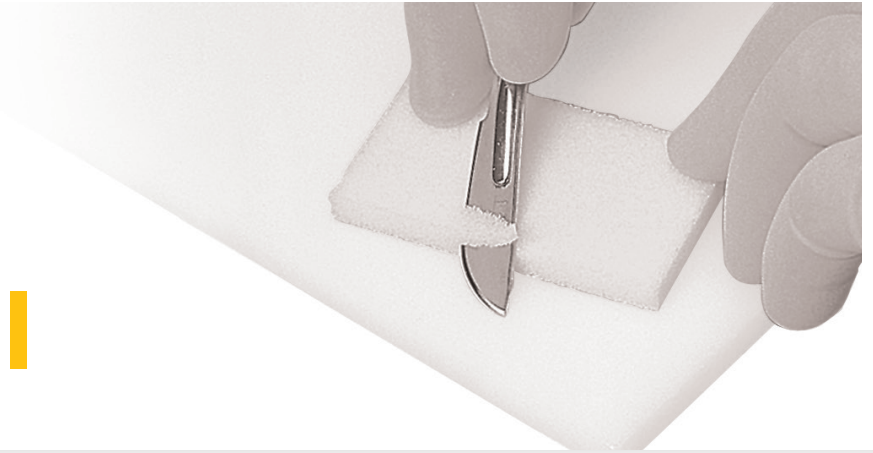

MEDPOR has been a trusted name in the industry since 1985, with hundreds of thousands of procedures performed, and hundreds of published clinical reports in reconstructive, cranial, oculoplastic, and cosmetic applications.

Our MEDPOR product line provides you an array of porous polyethylene solutions for your reconstruction and augmentation needs. We understand that bio-compatibility characteristics of implants are paramount to help surgeons achieve positive patient outcomes. The omni-directional pore structure of our polyethylene implants may increase implant acceptance by allowing the patient's native tissue to integrate with the implant. In addition to our comprehensive line of stock MEDPOR implants, we offer CT-based patient specific implants, putting the implant design in your hands.

- MEDPOR is easy to work with. The material can be trimmed with a blade in the sterile field, and carved and feathered intra-operatively for an excellent final fit.
- No pre-placing of fixation plates. MEDPOR can be easily drilled and fixated and is designed to accept screws and plates without cracking, giving the surgeon more flexibility in fixation options and placement.
- MEDPOR surgical implants can be cut with a variety of surgical instruments. Implants may require fitting to the defect area at the time of surgery. The implant edges can be delicately shaped and feathered for a smooth transition from the implant to the patient's own bony contour.
- MEDPOR surgical implants are provided sterile and should not be resterilized.
- Do not place or carve the implant on surgical drapes, surgical clothing or any other surface that may contaminate the implant with lint and other particulate matter.

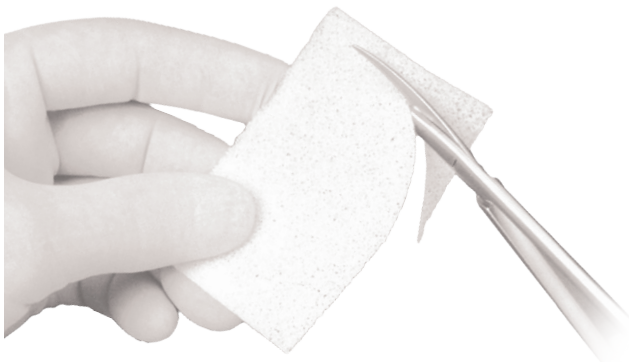

Temporal hollowing solutions

MEDPOR Pterional PLUS

CAT#	Description
5444-1-110	MEDPOR customized-PLUS - small
5444-1-210	MEDPOR customized-PLUS - medium
5444-1-310	MEDPOR customized-PLUS - large
5444-1-410	MEDPOR customized-PLUS - XL
5444-0-110	MEDPOR customized Cranial - small
5444-0-210	MEDPOR customized Cranial - medium
5444-0-310	MEDPOR customized Cranial - large
5444-0-410	MEDPOR customized Cranial - XL



Pterional PLUS is our exclusive patient specific implant intended for the correction and prevention of persistent temporal hollowing (PTH). This patient specific cranial implant is designed using the patient's own CT-data and anatomy, incorporating your surgical expertise, in order to estimate a patient's soft tissue atrophy and create an implant that accommodates for the atrophy. MEDPOR Pterional PLUS is delivered with two sterile implants and a sterile host-bone model.

Pterional PLUS was born out of our passion and commitment to working with our customers. Pterional PLUS is designed to serve as both a safe and effective solution for temporal hollowing, along with restoring the patient's original appearance.

We are the only company to offer the patent protected Pterional PLUS implant.

*Pterional PLUS available in both PEEK and MEDPOR material.

Additional off-the-shelf persistent temporal hollowing solutions

Pterional implant

The pterional implant is designed to correct temporal hollowing in patients who have had surgery involving the pterional approach to the brain. While the pterional craniotomy is one of the most versatile approaches in neurosurgery, it can lead to temporal hollowing.¹ The implant is placed deep to the temporalis during closure and is designed to correct this defect.

The pterional implant is available in left and right versions, and although similar to the FLEXBLOCK TF, is much smaller in design to provide appropriate augmentation.



CAT#	Description	A (mm)	B (mm)	Thickness
9864	Right	48	43	6.00
9865	Left	46	43	6.00
929865	Smooth-left	2	43	2.29
929864	Smooth-right	2	43	2.29

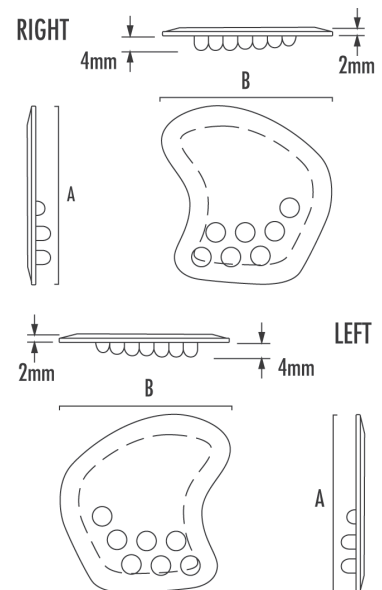

FLEXBLOCK implant

The FLEXBLOCK implant is available for small to medium sized cranial defects and contour deformities. It can be used as an onlay for small calvarial defects and contour defects.

The FLEXBLOCK implant has a smooth exterior surface and a series of pedicles on the interior surface that are designed to provide volume and flexibility. The outer perimeter and corresponding pedicles of the implant should be trimmed to provide a flange just larger than the defect for support and fixation.

1. The pedicles on the inferior surface of the implant are designed to provide flexibility to fit the implant to the desired contour.
2. The implant should be trimmed just larger than the defect. After cutting the implant to shape, the pedicles along the perimeter should be trimmed to provide a flange for fixation to the underlying bone.
3. A "shelf" in the surrounding bone may be created at the edge of the defect to provide for a more smooth transition.



CAT#	Description	A (mm)	B (mm)	Thickness (mm)
------	-------------	--------	--------	----------------

6314	FLEXBLOCK	56	91	4.00
------	-----------	----	----	------

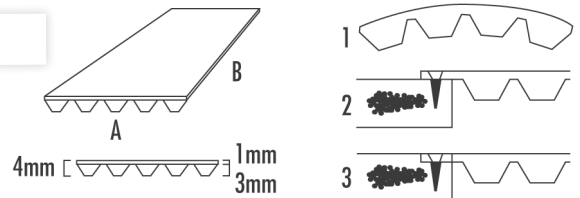

FLEXBLOCK TF2 & TF

The FLEXBLOCK TF2 and Flexblock TF implant shapes are designed to augment deficient soft tissue in the temporal region. The Flexblock TF2 comes in left and right versions and has a thinner, contoured temporal surface.



CAT#	Description	A (mm)	B (mm)	C (Thickness - mm)
------	-------------	--------	--------	--------------------

9857	TF2 small - left	61	78	18
9858	TF2 small - right	61	78	18
9859	TF2 medium - left	74	93	20
9860	TF2 medium - right	74	93	20
9861	TF2 large - left	82	105	20
9862	TF2 large - right	82	105	20
9521	TF small	70	70	10
9522	TF medium	86	88	15
9523	TF large	95	98	18

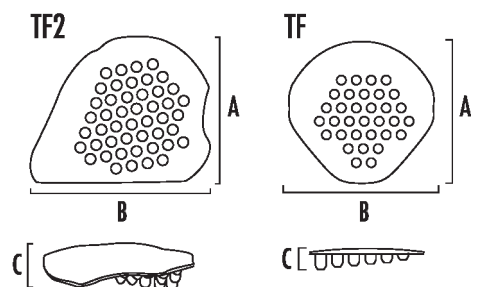

U.S. Patent 5,545,226

MEDPOR TITAN[®]

Combines high-density polyethylene and titanium mesh in a single implant for increased flexibility, shape retention, radiographic visualization and strength².

Configurations

MTM

Titanium mesh embedded within porous, high-density polyethylene.

MTB

Titanium mesh embedded within a porous polyethylene matrix with a solid, barrier surface on one side, potentially allowing for fibrovascular ingrowth only on the porous side of the implant.

BTB

Titanium mesh embedded within solid, non-porous high-density polyethylene. The smooth barrier surface can prevent fibrovascular ingrowth.

TITAN implants

MEDPOR TITAN sheets are intended for non-weight bearing applications of craniofacial reconstructive/cosmetic surgery, and repair of craniofacial trauma. Titanium mesh and MEDPOR polyethylene implants have a long history of successful use in trauma repair. When cut, traditional titanium mesh may exhibit many sharp points and edges that can make insertion difficult.

Titanium mesh embedded within a thin sheet of high-density polyethylene may minimize sharp edges even when the implant is cut. The titanium mesh is radiopaque, making the implant visible on radiographs or CT scans.³ The titanium mesh used in MEDPOR biomaterial allows the surgeon to bend and contour a thin implant material to the desired shape while providing the strength usually associated with a much thicker traditional MEDPOR implant.²

U.S. Patent #7,655,047

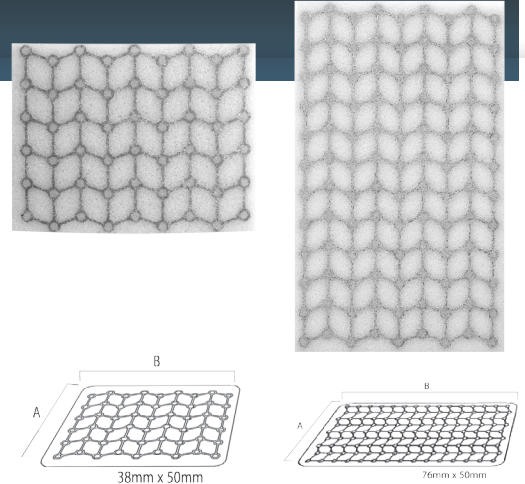

CAT# Description A (mm) B (mm) Thickness (mm)

CAT#	Description	A (mm)	B (mm)	Thickness (mm)
81020	MTM	50	76	0.85
81021	MTM	38	50	0.85
81022	MTM	38	50	1.50
81023	MTM	50	76	1.50
81024	BTB	38	50	0.60
81025	BTB	50	76	0.60
81026	MTB	38	50	1.00
81027	MTB	50	76	1.00
81028	MTB	38	50	1.60
81029	MTB	50	76	1.60

Surgeons may choose from three types of MEDPOR TITAN sheets:

- The MEDPOR TITAN MEDPOR (MTM) implant is porous, high-density polyethylene with titanium mesh embedded in it, potentially providing the advantages of fibrovascular integration of the patient's host tissue through the sheet.
- The MEDPOR TITAN BARRIER (MTB) implant is a sheet of titanium mesh embedded within a porous polyethylene matrix with a solid, BARRIER surface on one side, potentially allowing for fibrovascular ingrowth only on the porous side of the implant.
- The MEDPOR TITAN double BARRIER (BTB) implant is titanium mesh embedded within solid, high-density polyethylene that acts as a BARRIER to tissue attachment and may help facilitate implant placement.

TITAN cranial curve

The MEDPOR TITAN cranial curve and MEDPOR TITAN cranial curve - BARRIER implants offer the cranial surgeon an option for cranial/skull base reconstruction. Both configurations are pre-shaped to the general curvature of the cranium and are intended for non-loading bearing applications.

The titanium mesh used with the MEDPOR biomaterial allows the surgeon to further bend and contour the implant material to the desired shape.³

Titanium is radiopaque, making the implant visible on radiographs or CT scans.
U.S. Patent #7,655,047

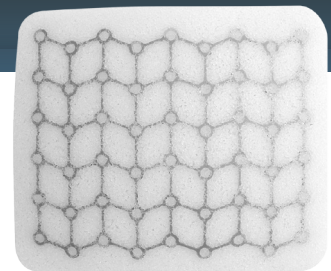

CAT# Description A (mm) B (mm) C (Thickness - mm)

CAT#	Description	A (mm)	B (mm)	C (Thickness - mm)
82019	TITAN cranial curve	38	48	0.85
82020	TITAN cranial curve - BARRIER	38	1.00	

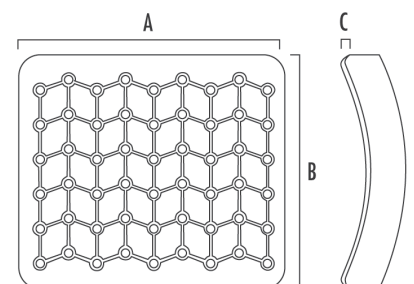

MEDPOR Neuro surgery

TITAN posterior implant

The MEDPOR TITAN posterior implant is intended for reconstruction of the cranium.

- Provides an option to other repair materials for reconstructing the cranium.
- May be trimmed and cut with surgical scissors. Polyethylene coating may minimize sharp edges of titanium when cut.³
- Titanium mesh embedded in the MEDPOR biomaterial is designed to help the implant retain its shape when bent and contoured to meet a specific patient defect.³

U.S. Patent #7,655,047

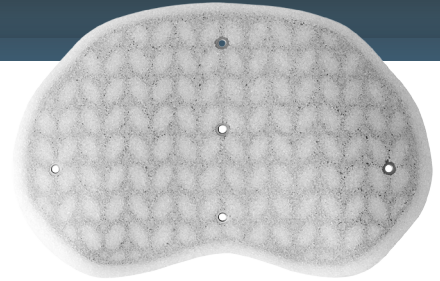

CAT#	Description	A (mm)	B (mm)	C (Thickness - mm)
82030	Posterior implant	96	61	1.50

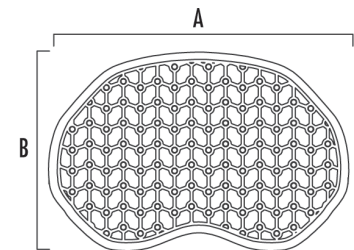

TITAN MAX sheet

The new MEDPOR TITAN MAX sheet is intended for non-weight-bearing applications of craniofacial reconstruction and repair of craniofacial trauma where a larger length and width implant is desired, compared to MEDPOR TITAN implants.

The MEDPOR TITAN MAX sheet is an alternative to bare titanium mesh for general cranial repair of small-to medium-sized defects. The titanium mesh used in the MEDPOR biomaterial is designed to help the implant retain its shape, which allows the surgeon to bend and contour the implant material to fit a patient-specific defect.

Provides MAX options for craniofacial reconstruction (*Compared to MEDPOR TITAN)

- Wider titanium mesh in a thin sheet* – 1.5mm sheet thickness
- Larger length and width* – 76mm x 100mm
- Alternative to bare titanium mesh for general cranial repair of small to medium size defects

Provides MAX benefits

- Biocompatible MEDPOR – 20 years of proven use in CMF applications – low risk for complications²
- Easily shaped and cut – convenient, may promote greater OR efficiency, fit to individual patient contours
- Easily fixated with plates/screws - designed to stay in place
- May allow for tissue ingrowth – enhances stabilization and possible reduced risk of long-term complications
- Polyethylene coating may minimize sharp titanium edges when cut
- Titanium mesh is radiopaque – visible on postoperative radiographs and CT scans

U.S. Patent #7,655,047

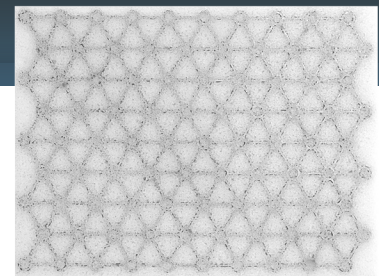

CAT#	Description	A (mm)	B (mm)	C (Thickness - mm)
81040	MTM	100	76	1.50

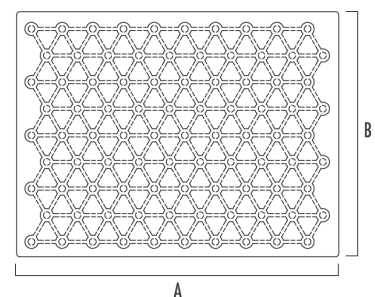

TITAN cranial-temporal

The MEDPOR TITAN cranial-temporal implant is designed to be an off-the shelf solution for non-weight-bearing applications of craniofacial reconstruction and repair of craniofacial trauma. The titanium mesh embedded in the MEDPOR biomaterial is designed to provide strength usually associated with a much thicker traditional MEDPOR implant. The thinner profile can be bent to the shape of the defect. The radiopaque titanium mesh makes the implant visible on postoperative radiographs or CT scans and helps the implant retain the shape when bent. The implant is available in left and right configurations.

Sterile template included.

U.S. Patent #7,655,047

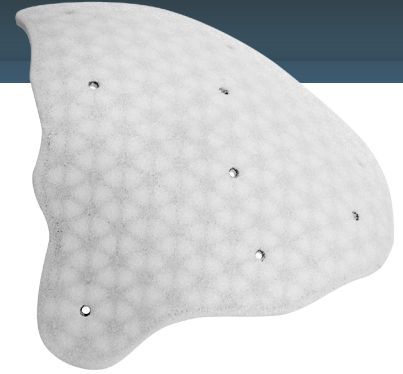

CAT#	Description	A (mm)	B (mm)	C (Thickness - mm)
------	-------------	--------	--------	--------------------

81037	TITAN cranial-temporal, left	130	130	3.00
81038	TITAN cranial-temporal, right	130	130	3.00

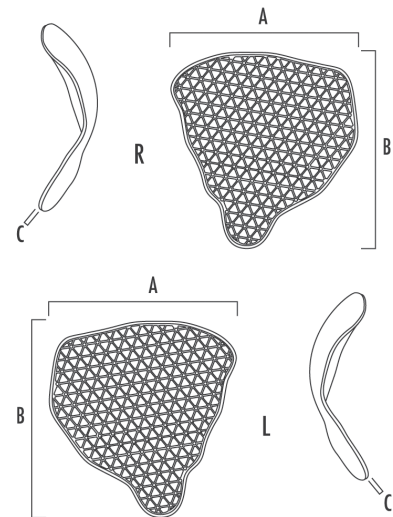

MEDPOR Neuro surgery

FLEXBLOCK cranial grid

The FLEXBLOCK cranial grid is designed to fill full thickness cranial defects as an option to calvarial bone grafts. The cranial grid has a grid design on the interior surface that is designed to provide strength and flexibility and allows the implant to be cut to the desired shape. The shape approximates the contour of the cranium. The implant is 6mm thick and 97mm x 106mm in dimension.



CAT#	Description	A (mm)	B (mm)	C (Thickness - mm)
9524	Cranial grid	97	106	6.00

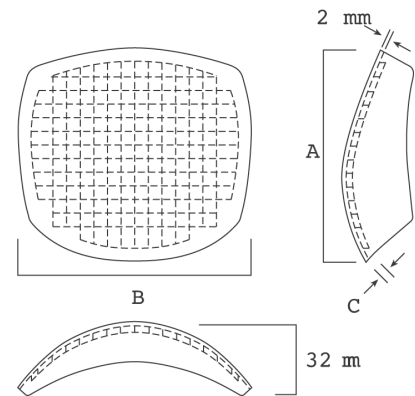

Blocks

The surgeon can carve thicker implants in the sterile O.R. field to obtain implant contours individualized for the surgical situation.

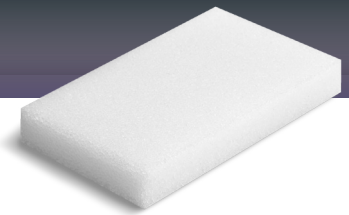

CAT#	Description	A (mm)	B (mm)	C (Thickness - mm)
6334	Blocks	13	38	9.50
6335	Blocks	25	50	3.00
6336	Blocks	25	50	6.00
6337	Blocks	25	50	9.50
6338	Blocks	38	63	3.00
6339	Blocks	38	63	6.00
6340	Blocks	38	63	9.50

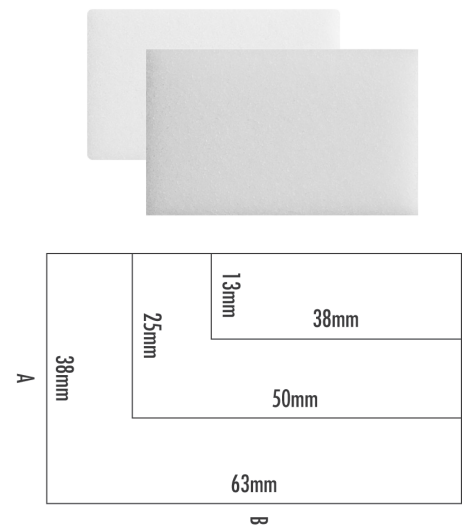

Sheets

MEDPOR biomaterial sheets provide the surgeon with options for craniofacial reconstruction and augmentation.

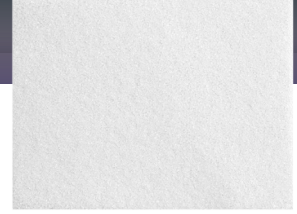

CAT#	Description	A (mm)	B (mm)	Thickness (mm)
83020	Micro thin sheet	38	50	0.25
83022	Micro thin sheet	38	50	0.35
8438	Micro thin sheet	30	50	0.40
83029	Micro thin sheet	38	50	0.45
83030	Micro thin sheet	50	76	0.45
7210	Ultra thin sheet	38	50	0.85
7212	Ultra thin sheet	50	76	0.85
7214	Ultra thin sheet	76	127	0.85
6330	Sheet	38	50	1.50
6331	Sheet	50	76	1.50
8662	Sheet	76	127	1.50
9562	Sheet	38	50	3.00

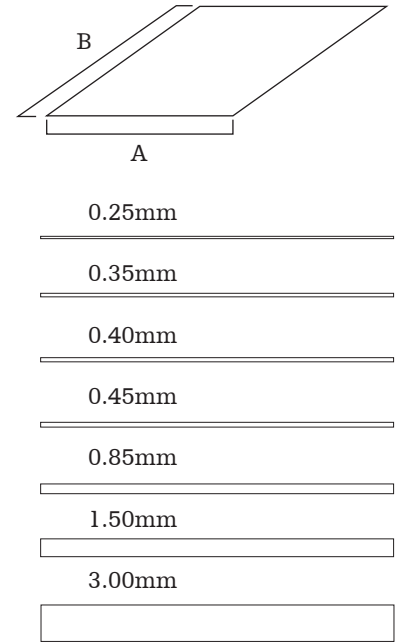

MEDPOR Neuro surgery

Cranial hemisphere

The MEDPOR cranial hemisphere for large cranial defects provides surgeons with an off-the-shelf alternative to customized implants, complex grafts, and other implant materials.

The implant shape approximates the contour of the half cranium. The cranial hemisphere is available in two thicknesses and left and right versions. The implant can be trimmed with a blade to fit the defect. The edges should be delicately shaped and feathered with surgical scissors or a scalpel blade for a smooth transition from the implant to the patient's bony contour. Fixation of the implant may be accomplished with rigid fixation plates and screws.

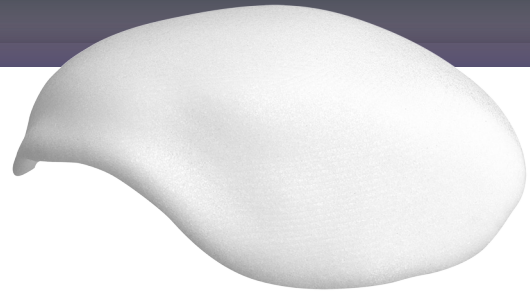

CAT#	Description	A (mm)	B (mm)	C (Thickness - mm)
82000	Cranial hemisphere - right	124	170	4.50
82001	Cranial hemisphere - left	124	170	4.50
82002	Cranial hemisphere - right	124	170	6.00
82003	Cranial hemisphere - left	124	170	6.00

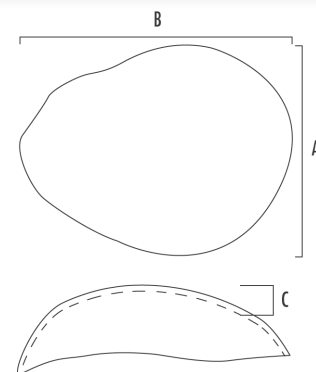

Cranial dome

The MEDPOR cranial dome is designed to provide surgeons with a reconstructive option for large cranial defects that encompass the dome area of the skull. The cranial dome approximates the contour of the superior one-third of the cranium and is available in two thicknesses.



CAT#	Description	A (mm)	B (mm)	C (Thickness - mm)
82004	Cranial dome	145	178	4.00
82006	Cranial dome	145	178	6.00

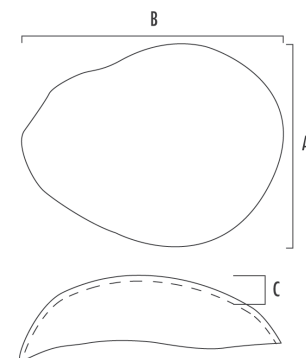

TSI

The MEDPOR TSI is designed to repair the seller floor.

The TSI implant is available in two sizes and configurations. The larger TSI is designed with three small tabs oriented to facilitate handling and placement while the original TSI design has a single tab.

A nonporous sheet of polyethylene heat-bonded to the posterior surface of the larger TSI forms a BARRIER to prevent tissue ingrowth.



CAT#	Description	A (mm)	B (mm)	C (Total thickness - mm)	D (mm)
82007	TSI	20	20	2.50	0.45
82008	TSI BARRIER - large	40	40	2.50	0.73
92-82007	TSI - large	40	40	2.50	0.73

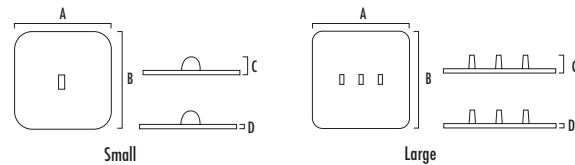

Mastoid implant

For patients undergoing cranial procedures that require removal of bone in the mastoid area, the MEDPOR mastoid implant provides surgeons with a convenient method to repair defect areas.

The implants are available in small and regular sizes and should be trimmed at the time of surgery to fit the needs of the individual patient.

The regular mastoid implant is available in left and right configuration, while the small mastoid implant provides a universal fit to either the left or right side.



CAT#	Description	A (mm)	B (mm)	C (Thickness - mm)
82014	Mastoid - small	36	45	1.00
82015	Mastoid implant - left	58	56	1.50
82016	Mastoid implant - right	58	56	1.50

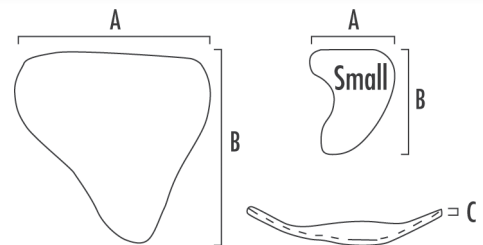

MEDPOR Neuro surgery

Complete and 2/3 orbit shapes

Complete and inferior 2/3 orbit implants are designed to replace non-load bearing, bony structures of the orbital area. Complete and 2/3 orbits are typically carved with a blade or scissors to fit the patient's defect and fixed with sutures, wires or craniofacial screws and plates.



CAT#	Description	A (mm)	B (mm)
9567	Inferior 2/3 orbit - left	108	75
9568	Inferior 2/3 orbit - right	108	75
9569	Complete orbit - left	93	75
9570	Complete orbit - right	93	75

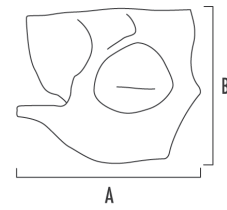

Complete Orbit

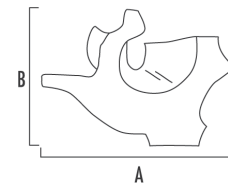

Inferior 2/3 Orbit

Orbito-Zygomatic (OZ)

The MEDPOR Orbito-Zygomatic (OZ) implant is designed for reconstruction of the superior and lateral surfaces of the orbital roof.

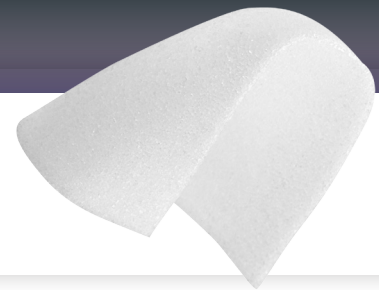

CAT#	Description	A (mm)	B (mm)	C (Thickness - mm)
81013	Left	33	38	0.80
81014	Right	33	38	0.80

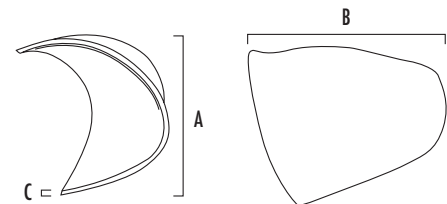

Craniotomy gap wedge V&T

The MEDPOR craniotomy gap wedge V&T are designed to fill a gap often left after a craniotomy. The craniotomy gap wedge V&T implants are triangle shaped implants designed to fit snugly into the gap along a bone flap. The revised craniotomy gap wedge V implant is a wedge-shaped strip that has a "U" shaped cross section. The craniotomy gap wedge T implant is designed with a thin flat section on the top surface extending 3mm on each side, for a total roof width of 10mm. Both designs measure 102mm in length. The implants are sold one of each style for a total of two implants per sterile package.

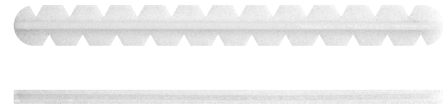

CAT#	Description	A (mm)	B (mm)	C (Thickness - mm)
82011	Craniotomy gap wedge V (1 per package)	102	4.00	3.60
	Craniotomy gap wedge T (1 per package)	102	4.60	10

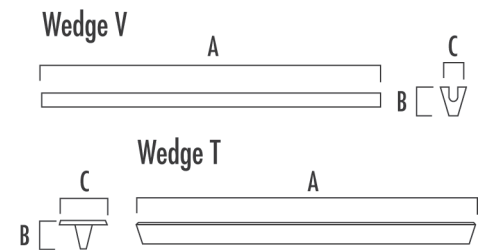

Burr hole covers

Burr hole covers are designed to fit into and over holes made by a cranial perforator. The superior flange is designed to cover any gaps between the cranial hole and the bone flap.

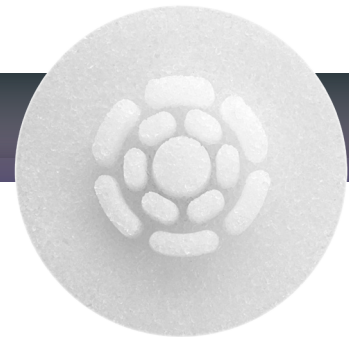

CAT#	Description	A (mm)	B (mm)	C (Thickness - mm)
7512	Burr hole cover	29	7	14

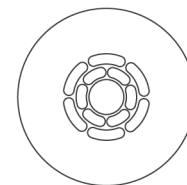
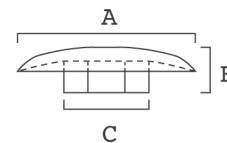

7512

Craniomaxillofacial

This document is intended solely for the use of healthcare professionals. A surgeon must always rely on his or her own professional clinical judgment when deciding whether to use a particular product when treating a particular patient. Stryker does not dispense medical advice and recommends that surgeons be trained in the use of any particular product before using it in surgery.

The information presented is intended to demonstrate a Stryker product. A surgeon must always refer to the package insert, product label and/or instructions for use, including the instructions for cleaning and sterilization (if applicable), before using any Stryker product. Products may not be available in all markets because product availability is subject to the regulatory and/or medical practices in individual markets.

Please contact your Stryker representative if you have questions about the availability of Stryker products in your area.

Stryker Corporation or its affiliates own, use, or have applied for the following trademarks or service marks: BARRIER, BTB, FLEXBLOCK, MAX, MTM, MTB, MEDPOR, MEDPOR TITAN, Stryker. All other trademarks are trademarks of their respective owners or holders.

Devices may not have been licensed in accordance with Canadian Law.

1. Zhong S., Huang G.J., Hua, J., Swanson E., Susarla S.M., Baltimore, MD. "Quantitative Analysis of Dual-Purpose, Patient-Specific Craniofacial Implants for Correction of Temporal Deformity" [February 2015]
2. Liu JK, Gotfried ON, Cole CD, Dougherty WR, Couldwell WT, "MEDPOR Porous Polyethylene implant for Cranioplasty and Skull Base Reconstruction" Neurosurgery [April 2004]
3. Holck, D., Foster J., and Dahl T., "Custom Shaped Porous Polyethylene-Titanium Mesh Orbital implants for Internal Orbital Floor/Medial-Wall Fracture Repair" ASOPRS 37th Annual Fall Scientific Syllabus, pp190, November 15-16, 2006

CMF-BR-102_Rev. None_14460

Copyright © 2017 Stryker

Printed in the USA

Stryker Craniomaxillofacial
Kalamazoo, MI 49002 USA
t: 269 389 5346
toll free: 800 962 6558
f: 877 648 7114

stryker.com/cmfb